

**Panasonic**  
ideas for life

**15A (1C), 10 A (2C)  
SPACE SAVING  
POWER RELAY**

**HL RELAYS**

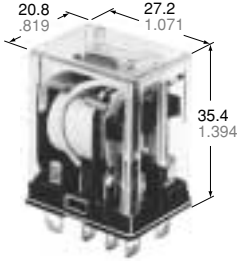

mm inch

## FEATURES

- **High switching capacity in a compact size**  
1 Form C (15 A 125 V AC), 2 Form C (10 A 250 V AC)
- **Rugged construction for tough applications**
- **Long life**  
Mechanical: Min.  $10^8$  operations (DC),  
Min.  $5 \times 10^7$  operations (AC)  
Electrical: Min.  $5 \times 10^5$  operations

## SPECIFICATIONS

### Contacts

Arrangement		1 Form C	2 Form C
Initial contact resistance, max. (By voltage drop 6 V DC 1 A)		50 mΩ	
Contact material		Silver alloy	
Rating (resistive)	Nominal switching capacity	15 A 125 V AC, 10 A 250 V AC	10 A 250 V AC
	Max. switching power	AC: 2,500 VA DC: 90 W	AC: 2,500 VA DC: 90 W
	Max. switching voltage	250 V AC 30 V DC	250 V AC 30 V DC
	Max. switching current	15 A	10 A
	Min. switching capacity <sup>#1</sup>	100 mA, 5 V DC	
Expected life	Mechanical (at 180 cpm)	$5 \times 10^7$ (AC), $10^6$ (DC)	
	Electrical (resistive)	15 A 125 V AC	$5 \times 10^5$
		10 A 250 V AC	$5 \times 10^5$
	3 A 30 V DC	$5 \times 10^5$	

#1 This value can change due to the switching frequency, environmental conditions, and desired reliability level, therefore it is recommended to check this with the actual load.

### Remarks

- \* Specifications will vary with foreign standards certification ratings.
- \*1 Measurement at same location as "Initial breakdown voltage" section
- \*2 Detection current: 10 mA
- \*3 Excluding contact bounce time
- \*4 Half-wave pulse of sine wave: 11ms; detection time: 10μs
- \*5 Half-wave pulse of sine wave: 6ms
- \*6 Detection time: 10μs
- \*7 Refer to 6. Conditions for operation, transport and storage mentioned in AMBIENT ENVIRONMENT

### Characteristics (at 25°C 77°F, 50% Relative humidity)

Max. operating speed	20 cpm	
Initial insulation resistance*1	Min. 100 MΩ (at 500 V DC)	
Initial breakdown voltage*2	Between contact sets	1,500 Vrms for 1 min.
	Between open contacts	1,000 Vrms for 1 min.
	Between contacts and coil	2,000 Vrms for 1 min.
Operate time (at nominal voltage)	Max. 25 ms (DC type) Max. 25 ms (AC type)	
Release time*3 (without diode) (at nominal voltage)	Max. 25 ms (DC type) Max. 25 ms (AC type)	
Temperature rise, max. (at nominal voltage)	Max. 80°C	
Shock resistance	Functional*4	Min. 196 m/s <sup>2</sup> {20 G}
	Destructive*5	Min. 980 m/s <sup>2</sup> {100 G}
Vibration resistance	Functional*6	10 to 55 Hz at double amplitude of 1 mm
	Destructive	10 to 55 Hz at double amplitude of 2 mm
Conditions for operation, transport and storage*7 (Not freezing and condensing at low temperature)	Ambient temperature	-50°C to +70°C -58°F to +158°F
	Humidity	5 to 85% R.H.
Unit weight	Approx. 35 g 1.25 oz	

## TYPICAL APPLICATIONS

Power station control equipment,  
refrigerators, building control equipment,  
office machines, and medical equipment.

## ORDERING INFORMATION

Ex. HL 2 — H — AC240V

Contact arrangement	Terminal arrangement	Coil voltage
1: 1 Form C 2: 2 Form C	H: Plug-in HP: PC board HTM: Top mounting L: Light emitting diode wired, plug-in PL: Light emitting diode wired, PC board	AC 6, 12, 24, 48, 120, 240 V DC 6, 12, 24, 48, 110 V

Note: Standard packing Carton: 20 pcs., Case: 200 pcs.  
UL/CSA approved type is standard.

# COIL DATA (at 20 °C 68°F)

## DC coils

Coil voltage, V DC	Pick-up voltage, V DC (max.)	Drop-out voltage, V DC (min.)	Max. allowable voltage, V DC	Coil resistance, Ω (±10%)	Nominal coil current, mA	Operating power, W	
						Nominal	Minimum
6	4.8	0.6	6.6	40	150	0.90	0.58
12	9.6	1.2	13.2	160	75		
24	19.2	2.4	26.4	650	37		
48	38.4	4.8	52.8	2,600	18.5	1.0	0.64
110	88.0	11.0	121.0	10,000	10		

## AC coils at 60 Hz

Coil voltage, V DC	Pick-up voltage, V AC (max.)	Drop-out voltage, V AC (min.)	Max. allowable voltage, V AC	Nominal coil current, mA	Operating power, VA	
					Nominal	Minimum
6	4.8	1.8	6.6	200	1.20	0.77
12	9.6	3.6	13.2	100		
24	19.2	7.2	26.4	50		
48	38.4	14.4	52.8	25		
110/120	88	36	132	10.9/11.9		
220/240	176	72	264	6.0/6.5		

**Notes:**

1. The range of coil current is ±15% for AC (60 Hz), ±10% for DC, at 20°C.
2. The relay may be used in the range of 80% to 110% of the nominal coil voltage. However, it is recommended that the relay be used at 85% to 110% nominal voltage to take temporary voltage variations into consideration.
3. Each coil resistance of DC types is the measured value at a coil temperature of 20°C. Please allow a compensation of ±0.4% resistance for each coil temperature change of ±1°C.

4. All AC 240 V types are rated for double coil voltages, both AC 220 V and AC 240 V.
5. For use with 220 or 240 V DC, connect a resistor, as suggested below, in series with the 110 V DC relay.

Voltage	1 Form C, 2 Form C
220 V DC	11 kW (5 W)
240 V DC	13 kW (5 W)

# DIMENSIONS

mm inch

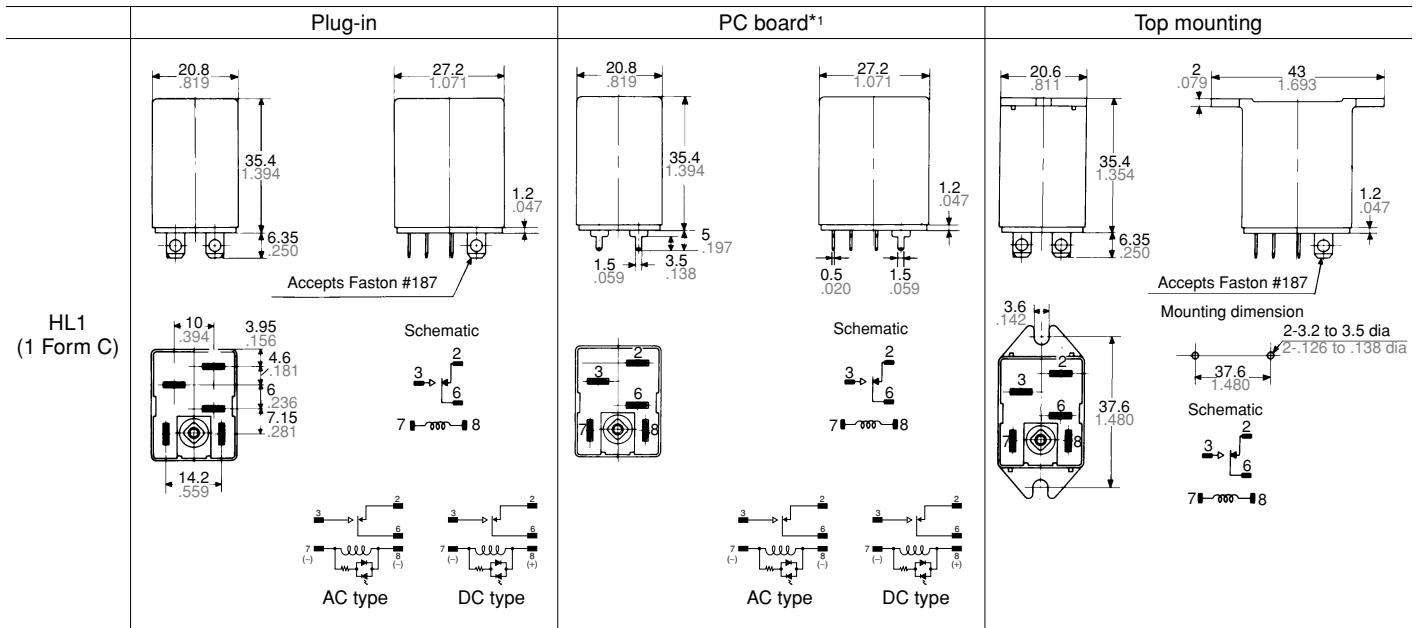

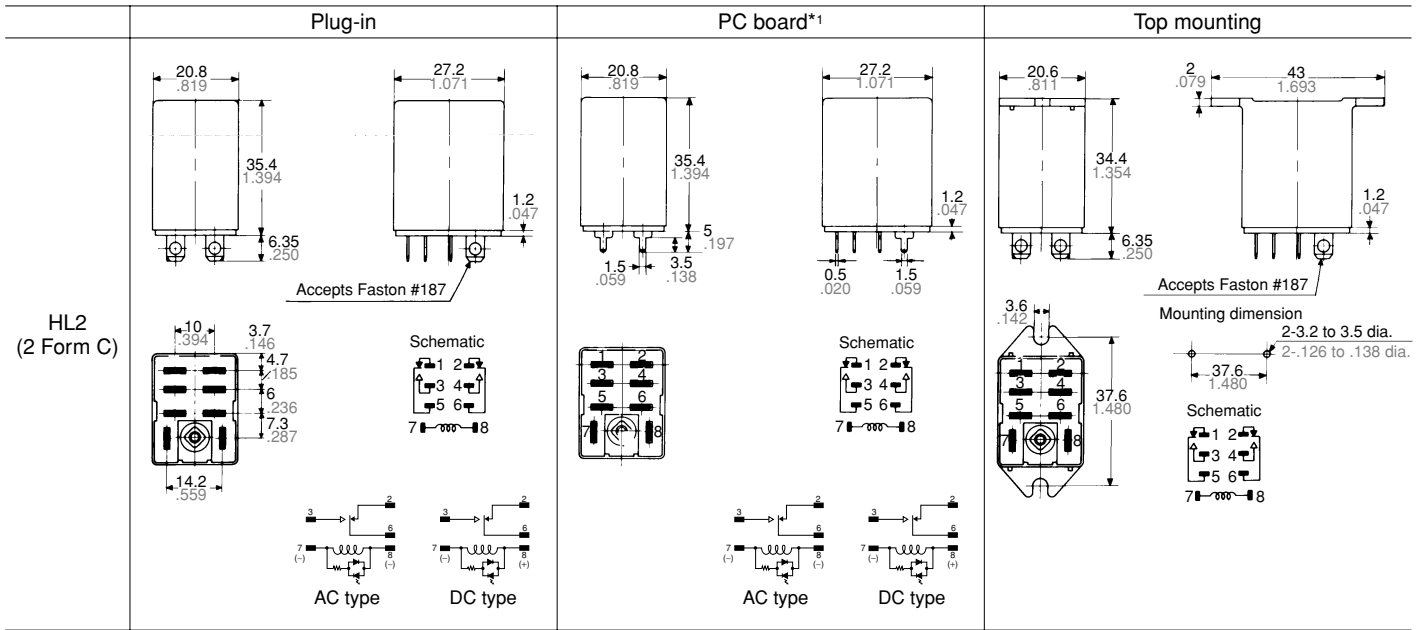

Tolerance:  $\pm 0.5 \pm .020$

\*1 PC board pattern

Copper-side view

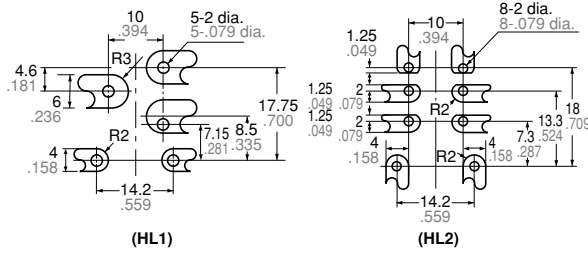
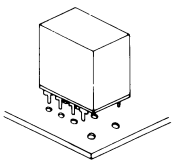

Tolerance:  $\pm 0.1 \pm .004$

## ACCESSORIES

HL1-SS-K (with hold-down clip)

HL2-SS-K (with hold-down clip)

Plug-in terminal socket mount  
Simply insert socket into panel hole and push down as indicated to lock socket in place.

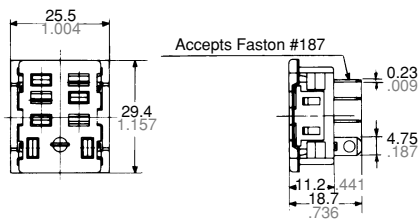
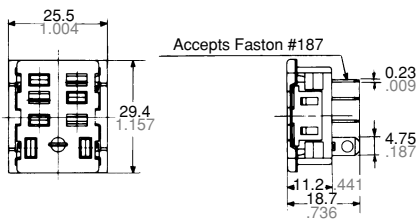
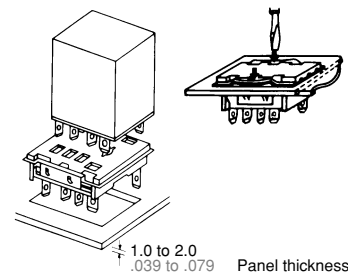

Panel cutout

Panel cutout

Panel cutout for tandem mounting

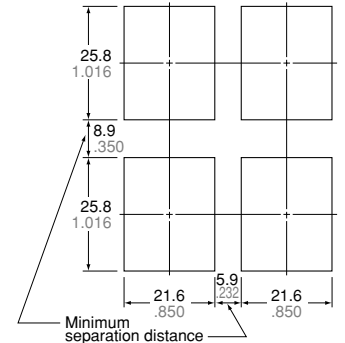
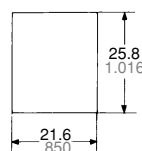
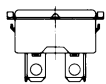
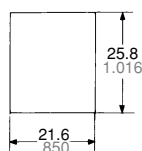
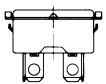

Tolerance:  $\pm 0.1 \pm .004$

2. PC board terminal socket

HL1-PS-K

HL2-PS-K

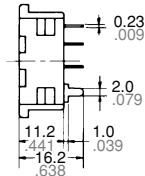
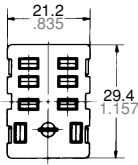

PC board pattern

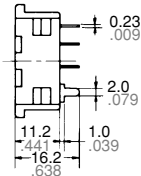
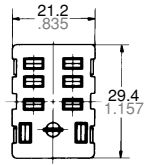
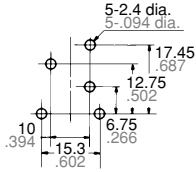

PC board pattern

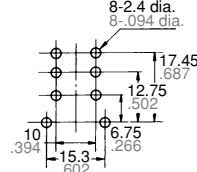

Layout for tandem mounting  
(2 Form C)

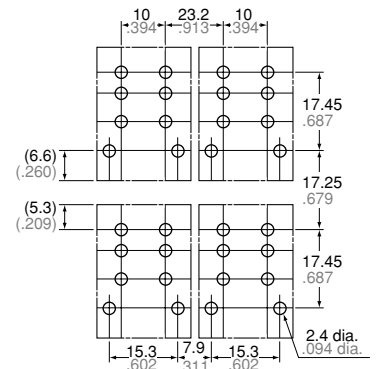

Tolerance:  $\pm 0.1 \pm 0.04$

3. Screw terminal socket for DIN rail assembly

HL2-SFD-K (with hold-down clip)

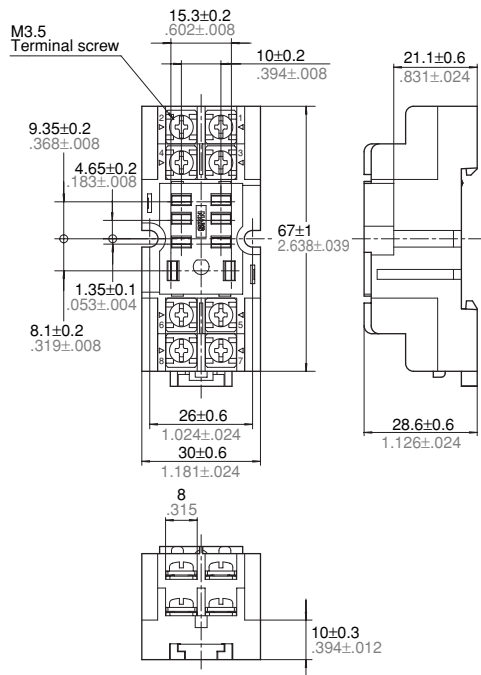
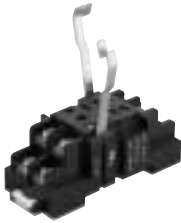

Schematic

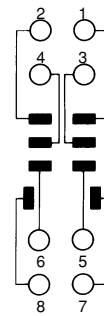

Layout for tandem mounting

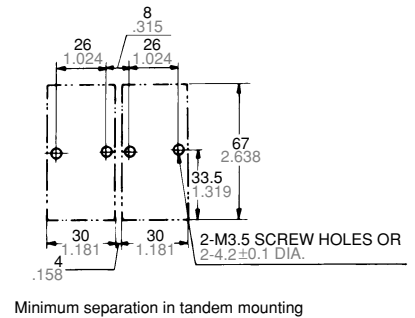

Minimum separation in tandem mounting

Tolerance:  $\pm 0.1 \pm 0.04$

(Remark) Max. continuous current of all HL sockets is 10 A.

For Cautions for Use, see Relay Technical Information